

Thru-Hull Chirp Transducers

Unlock the true potential of your fishfinder with the superior quality and performance of an AIRMAR Chirp-ready transducer.

B265LH screenshot courtesy of Furuno

The Benefits of AIRMAR's Chirp-ready Transducers

- One broadband transducer covers up to 117 kHz of bandwidth – greater opportunities to detect fish in the water column
- Superior resolution – precise separation between baitfish and gamefish represented on the display with crisp images
- Enhanced bottom fishing – resolve targets close to the bottom or near structure/wrecks
- Amazing detail – recognize haloclines and thermoclines
- Improved signal to noise ratio – find fish and track bottom at high boat speeds

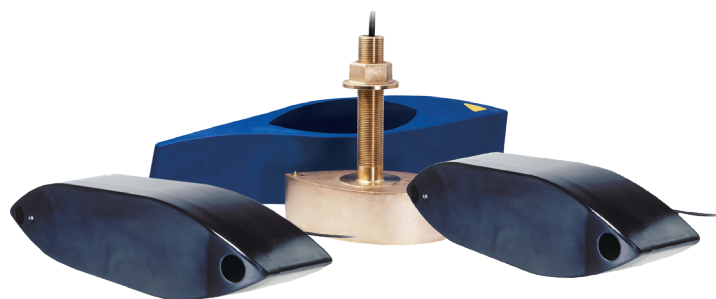

Benefits of Thru-Hull Transducers with High Performance Fairing

Thru-hull installations provide **best performance** compared with other installation options for many reasons.

- The best performance on vessels 25 feet and up because the transducer face is in "clean" water below the boundary layer (bubbles running down the hull)
- The fairing compensates for hull deadrise and reduces turbulence over the transducer face, which allows tracking at speeds over 30 knots (35 MPH)
- When mounted in clean water (forward of propellers and running gear), thru-hulls produce the most effective signal return since nothing on the vessel interferes with the transducer's active surface

Why does frequency matter?

Selecting the best frequency for your specific application is very important. The good news is that once you know what frequency will work best for the type of fishing you do, there's an AIRMAR transducer designed to maximize the performance of your sounder.

AIRMAR Chirp transducers are available in various frequency combinations:

- Dual Band:
 - Low/High (LH)
 - Low/Medium (LM)
 - Low/High Wide (LHW)
 - Low Wide/Medium (LWM)
- Single Band:
 - Low
 - Medium
 - Medium Ultra Wide (MW)
 - High
 - High Wide

Low Frequency = Greater Depth (ex. 42-65 kHz)

- Sound waves will not present as clear a picture of the bottom on the display, but will sound down in very deep areas where high frequency sound waves cannot reach
- Provides greater depth range, wider beamwidth, and ultimately more coverage under the boat
- Chirp signal processing technology used with AIRMAR broadband, Chirp-ready transducers provides more detail at greater depths and is less susceptible to noise
- Great for operating at high boat speeds

High Frequency = Greater Detail (ex. 130-210 kHz)

- More sensitive to small targets and will send back detailed information which will display as crisp, high-resolution images on the echosounder screen
- Best for shallower water and popular with anglers fishing at depths less than 1500 feet

Medium Frequency = The Best of Both Worlds (ex. 80-130 kHz)

- Provides the ability to sound deeper than the high frequency, along with better resolution than the low frequency
- Wider beam than the high frequency, achieving more coverage under the boat and greater opportunity to find fish
- Clear images at higher boat speeds

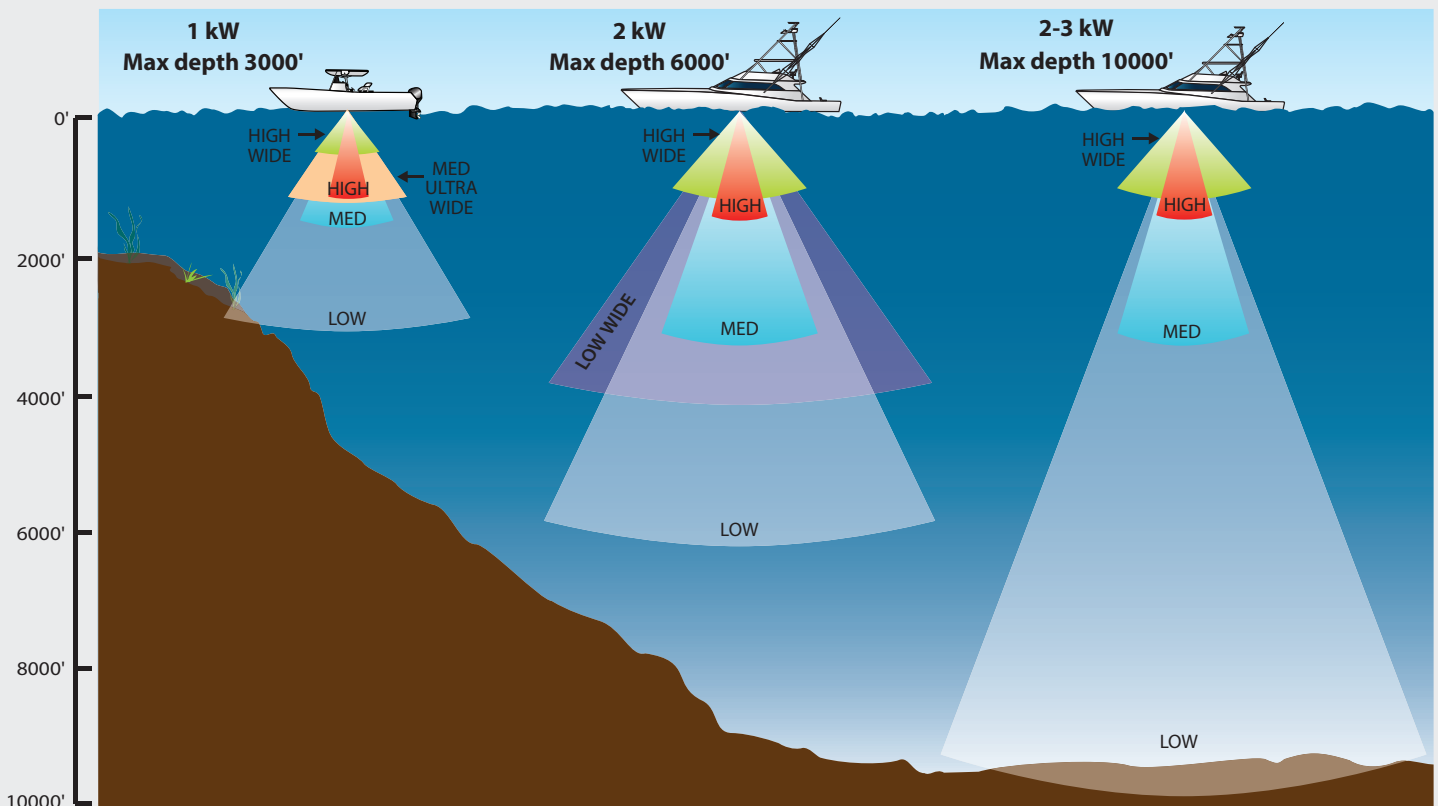

Thru-Hull 1 kW

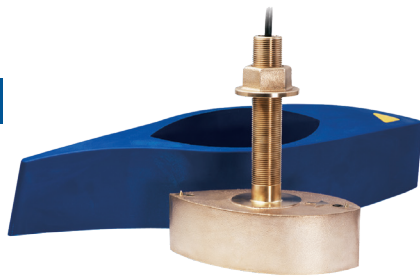

Features:

- Depth & fast-response water-temperature sensor
- Bronze transducer housing with High-Performance Fairing
- Boat Size: 8 m (25') and above
- Hull Type: Fiberglass or wood
- Engine Type: Inboard, Outboard or I/O
- For use on hulls up to 20° deadrise

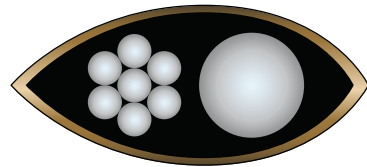

8-Internal
Broadband Ceramic
Assemblies

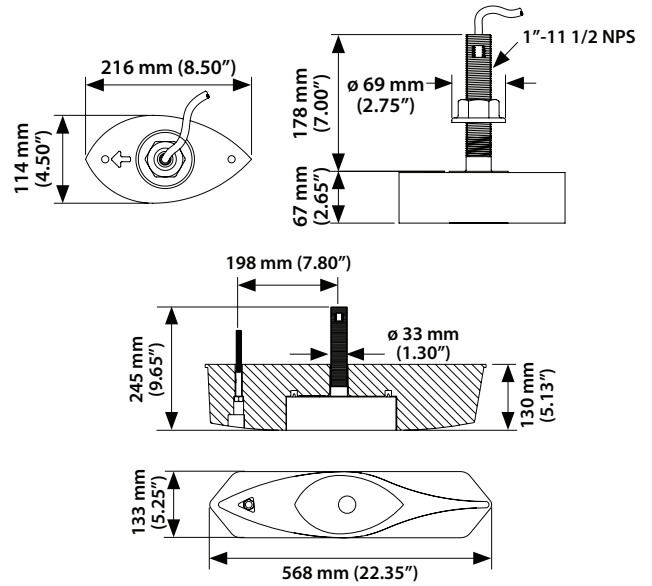

B265LH

Low & High Frequency

- Low—42 kHz to 65 kHz
25° to 16° beamwidth
Maximum depth 3000 ft
- High—130 kHz to 210 kHz
10° to 6° beamwidth
Maximum depth 1000 ft
- 103 kHz of total bandwidth from one transducer

B265LM

Low & Medium Frequency

- Low—42 kHz to 65 kHz
25° to 16° beamwidth
Maximum depth 3000 ft
- Medium—85 kHz to 135 kHz
16° to 11° beamwidth
Maximum depth 1500 ft
- 73 kHz of total bandwidth from one transducer

WIDE
BEAM

B275LHW

Low & High Frequency Wide-Beam

- Low—42 kHz to 65 kHz
25° to 16° beamwidth
Maximum depth 3000 ft
- High—150 kHz to 250 kHz
25° constant beamwidth
Maximum depth 500 ft
- 123 kHz of total bandwidth from one transducer

Bottom Coverage Relative to Frequency and Depth

Depth	Beam Coverage at Highest Frequency		
	B265LH 130 kHz-210 kHz	B265LM 85 kHz-135 kHz	B275LHW 150 kHz-250 kHz
50 ft	10 ft	14 ft	22 ft
100 ft	20 ft	28 ft	44 ft
300 ft	53 ft	84 ft	134 ft
600 ft	104 ft	168 ft	266 ft
1000 ft	174 ft	280 ft	Too Deep
1500 ft	Too Deep	420 ft	Too Deep
2000 ft	Too Deep	Too Deep	Too Deep

This chart compares the high and medium ceramic elements inside the transducer, showing the difference in bottom coverage under the boat.

The low frequency in each of these transducer models is the same (42 kHz - 65 kHz). The maximum depth range sounds to 3,000 ft.

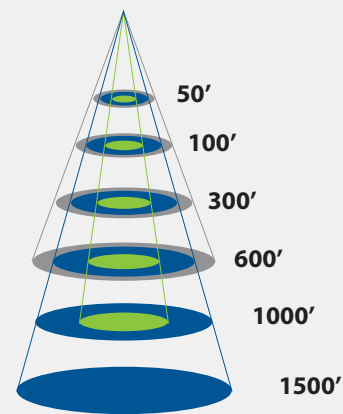

- B265LH – High Frequency
130 kHz-210 kHz
- B265LM – Medium Frequency
85 kHz-135 kHz
- B275LHW – High Frequency Wide-Beam
150 kHz-250 kHz

Thru-Hull 2 kW



Features:

- Depth & fast-response water-temperature sensor
- Urethane transducer housing with High-Performance Fairing
- Boat Size: 12 m (40') and above
- Hull Type: Fiberglass, wood, or metal
- Engine Type: Inboard, Outboard or I/O
- For use on hulls up to 22° deadrise

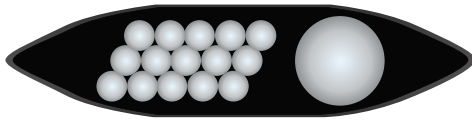

16-Internal
Broadband Ceramic
Assemblies

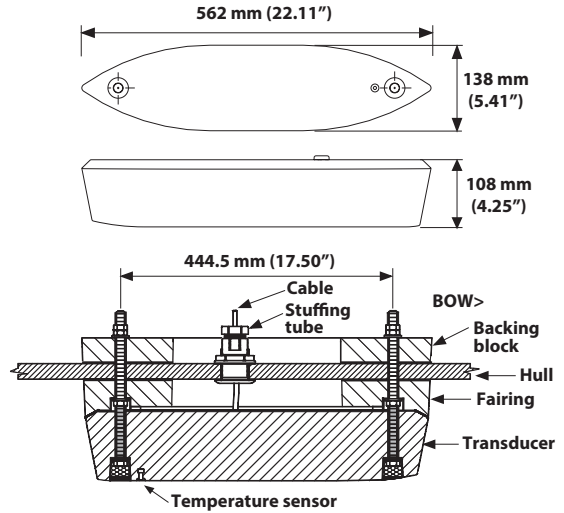

R109LH

Low & High Frequency

- Low-38 kHz to 75 kHz
19° to 10° port/starboard
10° to 5° fore-aft beam
Max. depth 6000 ft
- High-130 kHz to 210 kHz
8° to 4° beam
Max. depth 1500 ft
- 117 kHz of total bandwidth
from one transducer

R109LM

Low & Medium Frequency

- Low-38 kHz to 75 kHz
19° to 10° port/starboard
10° to 5° fore-aft beam
Max. depth 6000 ft
- Medium-80 kHz to 130 kHz
13° to 8° beam
Max. depth 3000 ft
- 87 kHz of total bandwidth
from one transducer

R109LHW

Low & High Frequency Wide-Beam

- Low-38 kHz to 75 kHz
19° to 10° port/starboard
10° to 5° fore-aft beam
Max. depth 6000 ft
- High-150 kHz to 250 kHz
25° constant beam
Max. depth 500 ft
- 137 kHz of total bandwidth
from one transducer

ULTRA
WIDE

R409LWM

Low Wide-Beam & Medium Frequency

- Low-40 kHz to 60 kHz
40° constant beamwidth
Max. depth 4000 ft
- Medium-80 kHz to 130 kHz
13° to 8° beam
Max. depth 3000 ft
- 70 kHz of total bandwidth
from one transducer

Bottom Coverage

Relative to Frequency and Depth

Depth	Beam Coverage at Highest Frequency			
	R109LH 130 kHz- 210 kHz	R109LM 80 kHz- 130 kHz	R109LHW 150 kHz- 250 kHz	R409LWM 40 kHz- 60 kHz
50 ft	6 ft	10 ft	22 ft	36 ft
100 ft	14 ft	24 ft	46 ft	73 ft
300 ft	42 ft	70 ft	134 ft	220 ft
600 ft	84 ft	136 ft	266 ft	440 ft
1000 ft	140 ft	226 ft	Too Deep	730 ft
1500 ft	210 ft	340 ft	Too Deep	1092 ft
2000 ft	Too Deep	456 ft	Too Deep	1456 ft

This chart compares the high and medium ceramic elements inside the transducer, showing the difference in bottom coverage under the boat.

Low frequency in each of these transducers models is the same (38-75 kHz) except the R409LWM. This low frequency can range to 6,000 ft.

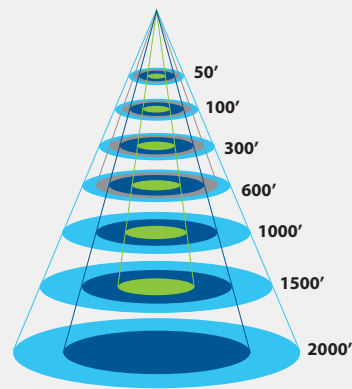

Thru-Hull 2-3 kW

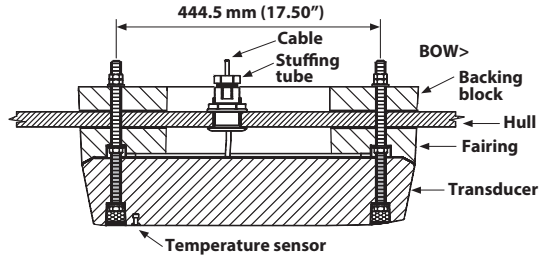
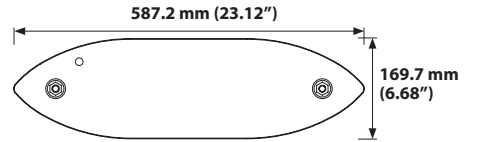

Features:

- Depth & fast-response water-temperature sensor
- Epoxy transducer housing with High-Performance Fairing
- Boat Size: 12 m (40') and above
- Hull Type: Fiberglass, wood, or metal
- Engine Type: Inboard, Outboard or I/O
- For use on hulls up to 25° deadrise

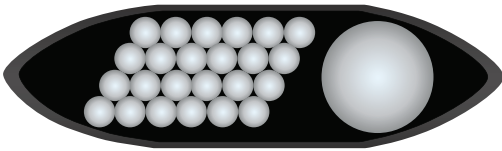

25-Internal Broadband Ceramic Assemblies

R509LH

Low & High Frequency

- Low-28 kHz to 60 kHz
23° to 9° port/starboard
11° to 5° fore-aft beamwidth
Maximum depth 10000 ft
- High-130 kHz to 210 kHz
8° to 4° beamwidth
Maximum depth 1500 ft
- 112 kHz of total bandwidth from one transducer

R509LM

Low & Medium Frequency

- Low-28 kHz to 60 kHz
23° to 9° port/starboard
11° to 5° fore-aft beamwidth
Maximum depth 10000 ft
- Medium-80 kHz to 130 kHz
13° to 8° beamwidth
Maximum depth 3000 ft
- 82 kHz of total bandwidth from one transducer

WIDE BEAM

R509LHW

Low & High Frequency Wide-Beam

- Low-28 kHz to 60 kHz
23° to 9° port/starboard
11° to 5° fore-aft beamwidth
Maximum depth 10000 ft
- High-150 kHz to 250 kHz
25° constant beamwidth
Maximum depth 500 ft
- 132 kHz of total bandwidth from one transducer

Bottom Coverage Relative to Frequency and Depth

Depth	Beam Coverage at Highest Frequency		
	R509LH 130 kHz-210 kHz	R509LM 80 kHz-130 kHz	R509LHW 150 kHz-250 kHz
50 ft	6 ft	10 ft	20 ft
100 ft	14 ft	24 ft	46 ft
300 ft	42 ft	68 ft	132 ft
600 ft	84 ft	136 ft	264 ft
1000 ft	140 ft	228 ft	Too Deep
1500 ft	208 ft	340 ft	Too Deep
2000 ft	Too Deep	456 ft	Too Deep
2500 ft	Too Deep	570 ft	Too Deep

This chart compares the high and medium ceramic elements inside the transducer, showing the difference in bottom coverage under the boat.

Low frequency in each of these transducer models is the same (28 kHz - 60 kHz).
The maximum depth range sounds to 10,000 ft.

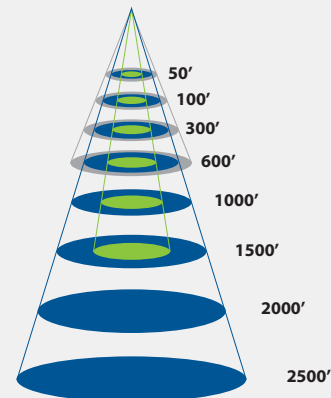

- R509LH – High Frequency
130 kHz-210 kHz
- R509LM – Medium Frequency
80 kHz-130 kHz
- R509LHW – High Frequency Wide-Beam
150 kHz-250 kHz

The Chirp Advantage

Traditional sounders operate at only two discrete frequencies – typically 50 kHz and 200 kHz. This results in limited depth range, resolution, and ultimately what targets can be detected in the water column.

In contrast, AIRMAR's game-changing Chirp-ready transducers provide over 70+ kHz of bandwidth. Transmitting over a wide frequency band results in a greater opportunity to detect what is in the water column. As a result, all targets detected in the entire bandwidth will be seen on the display—even those fish holding close to the bottom—ultimately improving target detection, detail, and range resolution.

Most Chirp transducers vary their beam width as they sweep through their frequency range (low, medium, and high). At the lowest frequency the beam is the widest and it narrows as the frequency increases.

AIRMAR's new wide beam Chirp transducers are the exception to this rule and have a fixed beam width of either 25° or 40° across the frequency band. This translates into even more coverage under the boat, revealing more fish in the water column than ever before.

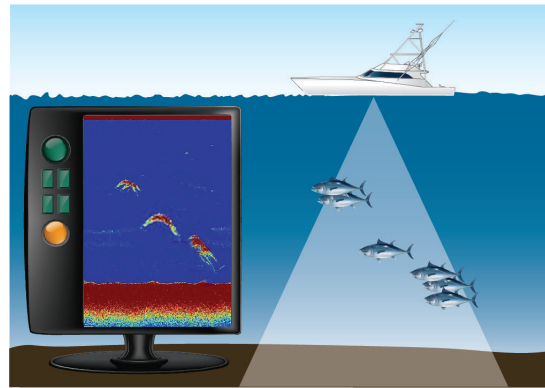
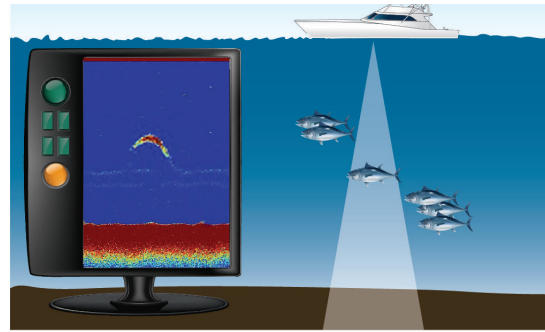

The fish must be in the beam to be represented on the display.

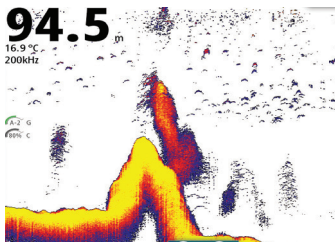

Courtesy of Navico

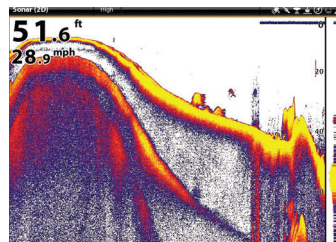

Courtesy of Humminbird

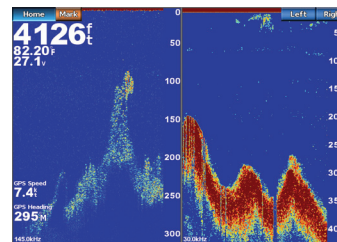

Courtesy of Garmin

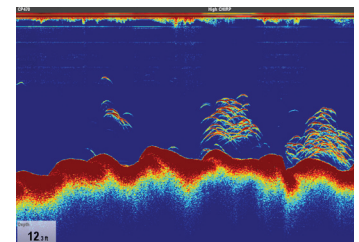

Courtesy of Raymarine

Additional Mounting Options

Choosing your mounting option depends on the design of the hull as well as the material it's manufactured with, the boats intended use, and the desired level of performance.

Tank Mount

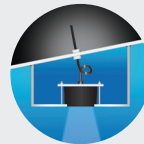

In-Hull



Pocket Mount

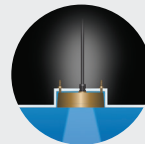

Keel Mount



www.airmar.com

©Airmar Technology Corporation

ThruHull Chirp_BR_rM 03/29/24

As Airmar constantly improves its products, all specifications are subject to change without notice. All Airmar products are designed to provide high levels of accuracy and reliability, however they should only be used as aids to navigation and not as a replacement for traditional navigation aids and techniques. Xducer ID™ is a registered trademark of Airmar Technology Corporation. Other company or product names mentioned in this document may be trademarks or registered trademarks of their respective companies, which are not affiliated with Airmar.